

REDUCED VOLTAGE SOFT STARTER MANUAL





MOTOR SOFT STARTER | 208 V – 460 V
MOTOR PROTECTION | REDUCES INRUSH CURRENT

















SAFETY MESSAGES AND WARNINGS









To ensure safe and reliable operation of Phase Technologies soft starters, it is important to carefully read and understand this manual and to read and observe all warning labels attached to the soft starter before installing the equipment. Please follow all instructions exactly and always keep this manual with the equipment for quick and easy reference.

Definitions of Warning Signs and Symbols

-  **CAUTION:** Indicates a potentially hazardous situation that could result in injury or damage to the product.
-  **WARNING:** Indicates a potentially hazardous situation that could result in serious injury or death.
-  **HIGH VOLTAGE:** Indicates high voltage. The voltage associated with the procedures or operations referenced could result in serious injury or death. Use caution and follow instructions carefully.

READ THESE WARNINGS BEFORE INSTALLING OR OPERATING EQUIPMENT!

-  **WARNING:** Risk of electric shock. De-energize the unit by disconnecting all incoming sources of power before servicing the equipment.
-  **HIGH VOLTAGE:** This equipment is connected to line voltages that can create a potentially hazardous situation. Electric shock could result in serious injury or death. This device should be installed only by trained, licensed, and qualified personnel. Follow instructions carefully and observe all warnings.
-  **WARNING:** This equipment should be installed and serviced by qualified personnel familiar with the type of equipment and experienced in working with dangerous voltages.
-  **WARNING:** Installation of this equipment must comply with the National Electrical Code (NEC) and all applicable local codes. Failure to observe and comply with these codes could result in risk of electric shock, fire, or damage to the equipment.
-  **CAUTION:** The **AUX1** and **AUX2** terminals are galvanically isolated, with approximately 15V potential between them. DO NOT apply voltage to the terminals. Use dry contacts only.
-  **CAUTION:** Circuit breakers or fuses, proper ground circuits, disconnect and other safety equipment and their proper installation are not provided by Phase Technologies, LLC, and are the responsibility of the end user.
-  **WARNING:** Suitable for use in a circuit capable of delivering not more than
 - 50 kA RMS at 240 VAC
 - 25 kA RMS symmetrical amperes at 240 VAC when a circuit breaker is installed
 - 25 kA RMS symmetrical amperes at 480 VAC.
-  **WARNING:** Wire used in the motor circuit and all field wiring terminals must be rated at least 60 °C.
-  **WARNING:** Use wire size suitable for Class 1 circuits.
-  **WARNING:** Input power connections should be made by a qualified electrician into a voltage source, with adequate current carrying capacity. Branch circuit protection to the soft starter should be provided by appropriately sized fuses or circuit breaker. Circuit breaker and fuse ratings for each model are listed in **Table 4**.
-  **WARNING:** These devices are equipped with integral solid-state short circuit protection. Integral solid-state short circuit protection does not provide branch circuit protection. Branch circuit protection must be provided in accordance with the National Electrical Code and any additional local codes.
-  **CAUTION:** Use 600 V vinyl-sheathed wire or equivalent. The voltage drop of the leads needs to be considered in determining wire size. Voltage drop is dependent on wire length and gauge. Use copper conductors only.
-  **CAUTION:** Wires fastened to the terminals shall be secured by tightening the terminal screws to a torque value listed in **Table 4**.
-  **CAUTION:** The maximum wire gauge for the input and output terminals are listed in **Table 4**.
-  **CAUTION:** Never allow bare wire to contact the metal surfaces.
-  **CAUTION:** Never connect AC main power to the output terminals U, V, and W.

-  **WARNING:** Under certain conditions, the motor may automatically restart after a fault has stopped it. Make sure power to the soft starter has been disconnected before approaching or servicing the equipment. Otherwise, serious injury may occur.
-  **WARNING:** Ingesting coin cell batteries can cause severe internal injuries or death. Store batteries out of reach of children, seek immediate medical attention if ingestion occurs, and follow any other consensus medical advice.
-  **CAUTION:** Use caution when applying power to the main input terminals of the unit. If the soft starter is programmed to allow automatic restarts, the soft starter will initialize in AUTO mode and the motor load may start as soon as the soft starter is energized.
-  **CAUTION:** The AC motor load must be connected directly to the output terminals of the soft starter. Do not install relays, disconnect switches, or wire nuts between the soft starter and the motor load.
-  **CAUTION:** Before the motor is connected to the output terminals, check all output lines for line-to-ground faults using a megger.
-  **CAUTION:** Before touching any printed circuit board, place a hand on a bare metal surface of the unit to discharge any static electricity. Electrostatic discharge (ESD) can damage printed circuits and their components.
-  **CAUTION:** When the parameter, **1.2.1 ENABLE RESTARTS**, is set to YES, the soft starter will energize in AUTO mode. The motor load may automatically run as soon as the soft starter is energized. To stop the motor, push the STOP/OFF key until the display indicates MANUAL or OFF, or open AUX1 or AUX2.
-  **CAUTION:** Operating the system in MANUAL mode on the keypad overrides remote signals from any remote controls.

1 INTRODUCTION 6

2 MODELS AND RATINGS 7

 2.1 Specifications 7

 2.2 Model Ratings 7

 2.3 Model Nomenclature 7

 2.4 Dimensional Drawings 8

3 INSTALLATION 10

 3.1 Mounting 10

 3.2 Ambient Temperature Rating 10

 3.3 General Wiring Considerations 10

 3.4 Installing Power Cables 11

 3.5 Control Terminals 11

 3.6 Short Circuit Protection 12

4 KEYPAD & DISPLAY 13

 4.1 Using the Keypad and Display 13

 4.2 Keypad Main Menu Items 14

 4.3 Change Parameter Values 14

 4.4 Read Measured Values 15

 4.5 Read Timers 15

 4.6 Restart Log 15

 4.7 Fault Log 16

 4.8 Clear Memory 16

 4.9 Setup Wizard 17

5 ADJUSTABLE PARAMETERS 18

 5.1 Changing Parameter Values 18

 5.2 Restore Default Parameter Settings 18

 5.3 Auto Restarts 18

 5.4 All Parameters List 18

 5.5 Changed Parameter List 19

 5.6 File System 19

 5.7 Menu Structure Overview 21

 5.8 Parameter Tables 22

6 OPERATION 25

 6.1 Commissioning the Unit 25

 6.2 Soft Starter Setup Procedure 25

6.3 Start Modes..... 25

6.4 Ground Fault Sensitivity..... 26

6.5 Motor Overload Protection..... 26

6.6 Start-Up and Shut-Down Ramp Times 26

6.7 Select Preset..... 26

7 TROUBLESHOOTING..... 28

7.1 Fault Codes..... 28

7.2 Clearing a Fault..... 28

7.3 Fault Log..... 30

8 ROUTINE INSPECTION AND MAINTENANCE 30

9 WARRANTY POLICY 33

1 INTRODUCTION

Phase Technologies Soft Starters are solid-state devices designed to gradually ramp voltage to three-phase AC motors, reducing inrush current and mechanical stress during startup. They provide reliable motor starting and stopping through a simple, user-friendly interface. Phase Technologies Soft Starters are also equipped with a contactor large enough for AC3 motor starting currents up to the rating of the device, that can be used to bypass the soft start function if the device is damaged.

The following block diagrams illustrate how Soft Starters ramp up the voltage supplied to the motor by controlling the conduction angle of the incoming AC power, thereby reducing inrush current and mechanical stress during startup.

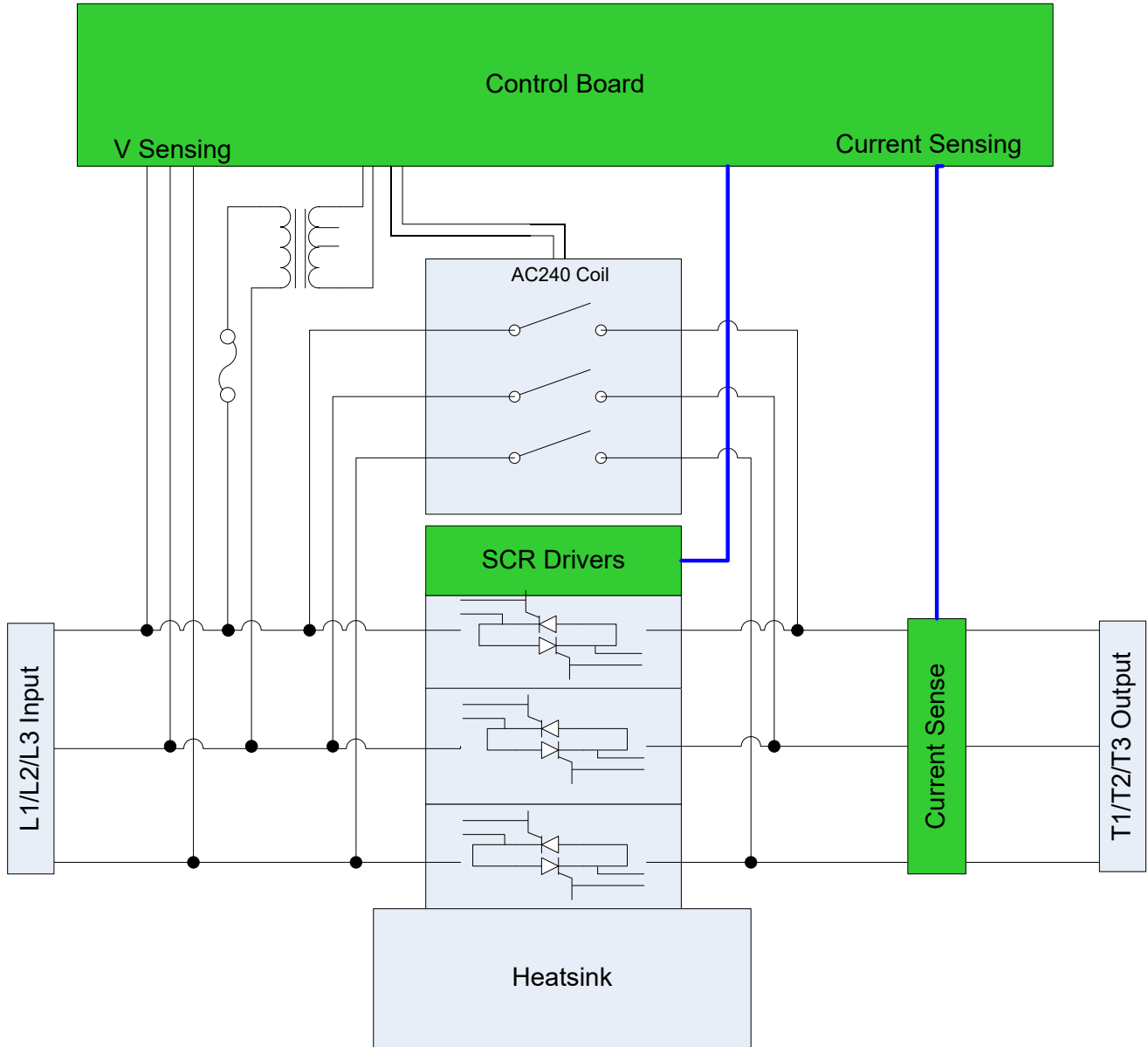

Figure 1 – Soft Starter Block Diagram

This manual contains instructions on selecting, installing, commissioning, and maintaining Phase Technologies Soft Starters.

2 MODELS AND RATINGS

2.1 Specifications

Table 1 – Soft starter Specifications

Specs	Range
Operating Temperature	-20°C – 55°C (-4°F – 131°F)
Storage Temperature	-40°C – 60°C (-40°F – 140°F)
Enclosure	Open, NEMA 1, or NEMA Type 3R
Input Frequency	50/60 Hz (3-phase)
Output Frequency	Equal to Input
Starts/Hour	10
Short Circuit Current Rating @ 240 V (No MCCB)	50 kA RMS symmetrical Amperes
Short Circuit Current Rating @ 240 V (With MCCB)	25 kA RMS symmetrical Amperes
Short Circuit Current Rating @ 480 V	25 kA RMS symmetrical Amperes
Certification	UL 60947-4-2

2.2 Model Ratings

Table 2 – Soft Starter Ratings

Model / Part Number	HP (240 V / 480 V)	Input Voltage	Rated Current (Input and Output)	Motor Starting (Bypass Mode)				Frame Size
				UL		IEC (AC3)		
				240 V	480 V	240 V	480 V	
SS040	15 / 30	240 VAC/480 VAC*	40 A	15 HP	30 HP	40 A	32 A	1
SS080	30 / 60		80 A	30 HP	60 HP	80 A	75 A	
SS130	50 / 100		130 A	50 HP	100 HP	130 A	100 A	

*Wired for 480 V operation. See Section 3.3 for details for use with 230 V.

2.3 Model Nomenclature

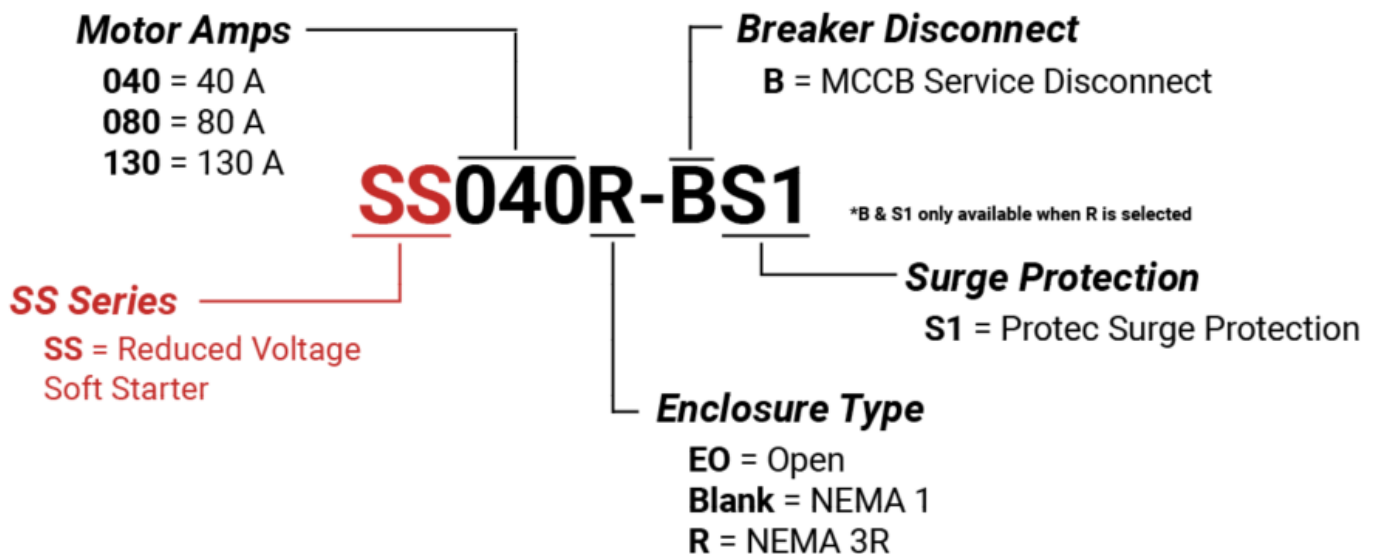
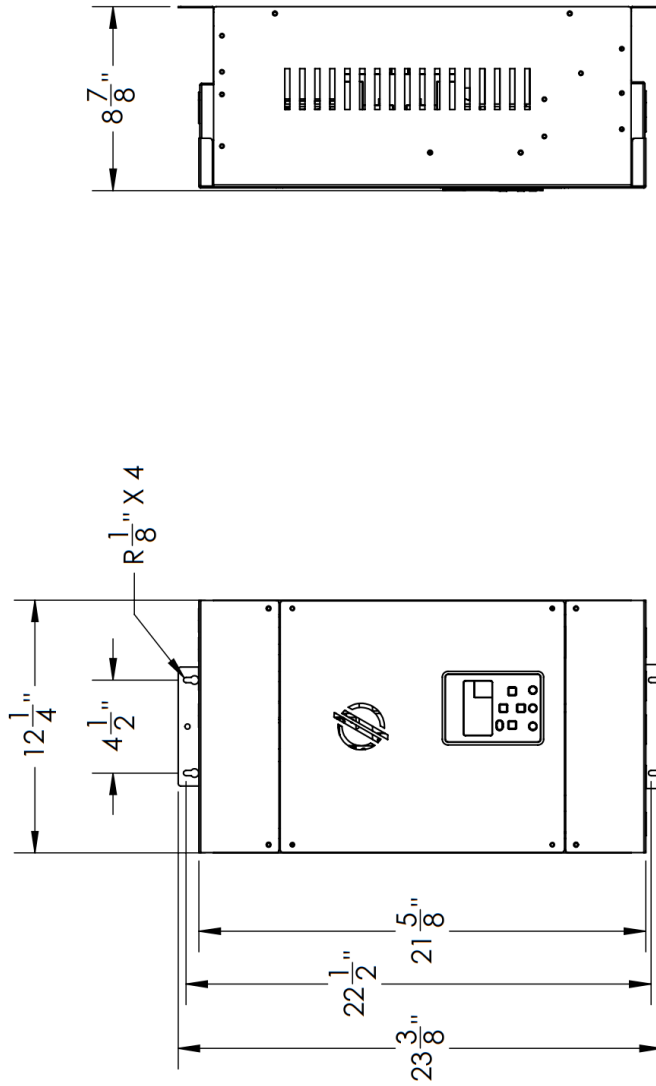

Figure 2 – Soft Starter Nomenclature

2.4 Dimensional Drawings



This drawing and any information contained within is the confidential and copyright property of Phase Technologies, LLC. IT MUST NOT BE DISCLOSED, COPIED, LOANED in whole or part or used for any purpose without the written permission of Phase Technologies, LLC.

UNLESS OTHERWISE SPECIFIED: FRACTIONAL ± 1/4" ANGLES: ± 1°		Drawing Title: Soft Start - NEMA 1	Drawing No: DOC0224-0
Scale: 1:8	Sheet: 1 of 1	Date: 11/6/2025	Units: IN

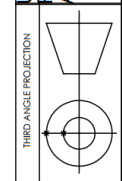
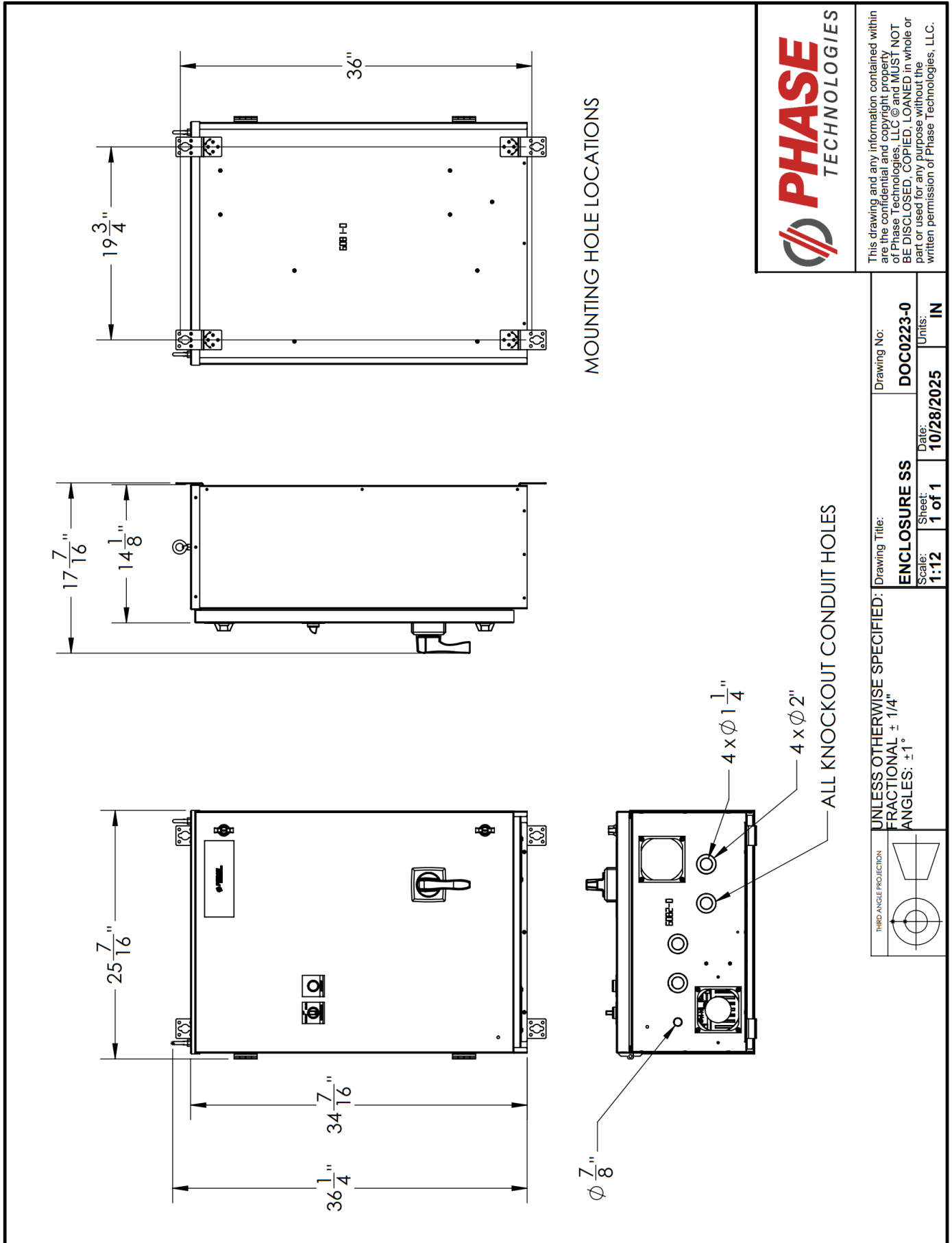

Figure 3 – Type 1 Enclosure Line Drawing



MOUNTING HOLE LOCATIONS



This drawing and any information contained within are the confidential and copyright property of Phase Technologies, LLC © and MUST NOT BE DISCLOSED, COPIED, LOANED in whole or part or used for any purpose without the written permission of Phase Technologies, LLC.

Drawing Title:		ENCLOSURE SS		Drawing No:		DOC0223-0	
Scale:		1:12		Date:		10/28/2025	
Sheet:		1 of 1		Units:		IN	

UNLESS OTHERWISE SPECIFIED:
 FRACTIONAL ± 1/4"
 ANGLES: ±1°

THIRD ANGLE PROJECTION

Figure 4 – NEMA 3R Enclosure Line Drawing

3 INSTALLATION

3.1 Mounting

The soft starter must be mounted in an upright position with adequate clearance for maintenance access. The mounting surface must be sturdy, non-flammable, and capable of bearing the weight of the unit. Fasten the unit to the mounting surface using screws or bolts of an appropriate size through the holes in the mounting brackets.

3.2 Ambient Temperature Rating

Phase Technologies Soft Starters are intended for use in ambient temperatures up to 55°C (131°F). Ensure there is at least 3 inches of open space on all sides of the enclosure to keep vents unobstructed.

3.3 Voltage Selection

By default, Phase Technologies Soft Starters are wired for 480 V and require modification for use on 240 V circuits. To rewire for 240 V

1. Locate the fuse board (shown below). Some models have a removable panel on the side for fuse access.
2. Disconnect the wires landed on J1, J3, and J7 terminals and set aside, ensuring they cannot cause an electrical short.
3. Use the cable assembly found in the packaging and land the 2-pin connector on J7.
4. Next one of the wires to J1 and the other wire to J3.

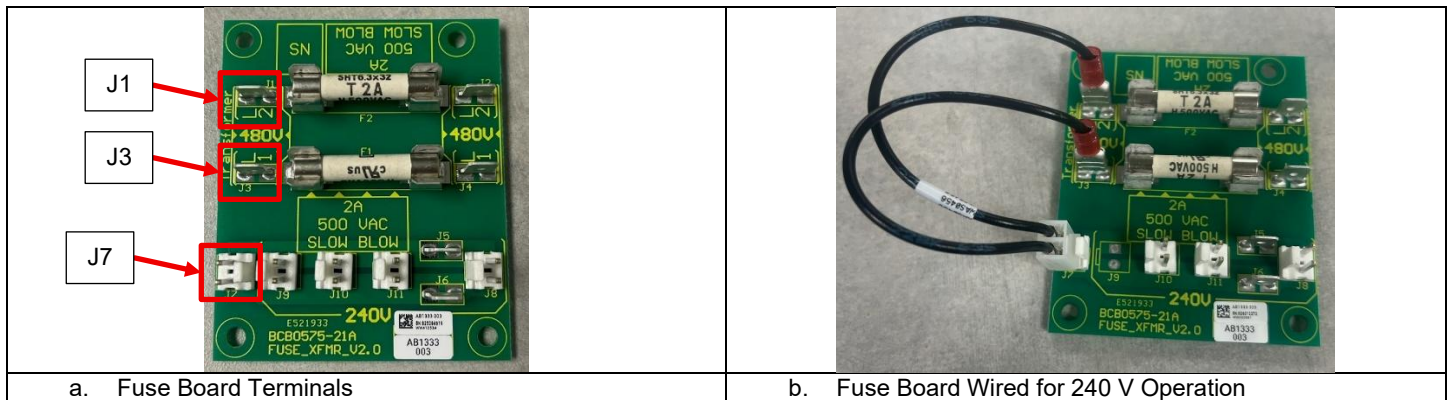

Figure 5 – Fuse Board Rewiring for 240 V Supply

3.4 General Wiring Considerations

Installations must comply with all NEC and local electrical code requirements. Circuit breaker and/or fuse size, listed in **Table 4**, are maximum allowable sizes, not recommended sizes. The NEC dictates that circuit breakers must be rated at least 25% higher than the input current rating.

Table 3 – Power Terminal Descriptions

Terminal Name	Description
L1, L2, L3 (Line)	Input power terminals
U, V, W (Load)	3-Phase output power terminals
GND	Earth safety ground

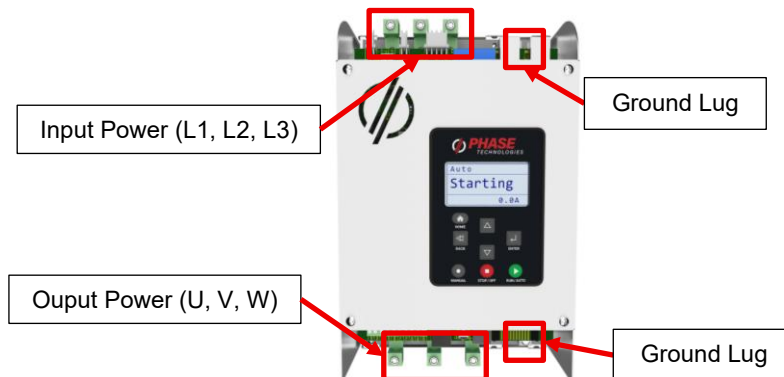

Figure 6 – Soft starter Power Terminal Location

Table 4 – Soft Starter Input Circuit Breaker and Fuse Ratings (Inverse Time Circuit Breaker)

Model	Input/Output		Maximum Circuit Breaker / Fuse Rating Class J
	Wire Size Range	Torque (lb-in)	
SS040	2 – 4 AWG	50	100 A
	6 – 10 AWG	40	
	12 – 14 AWG	15	
SS080	2 – 4 AWG	50	200 A
	6 – 10 AWG	40	
	12 – 14 AWG	15	
SS130	4/0 – 2 AWG	375	325 A
	2 – 6 AWG	275	

3.5 Installing Power Cables

⚠ CAUTION: In 3R panels, continuous metal conduit should be used on all power cables, both line and load side, to reduce conducted and emitted radiation of electromagnetic interference (EMI). The conduit must be securely grounded to the enclosure of the soft starter and the motor case. If any conduit holes remain unused, they must be covered with a 3R hole plug to maintain the NEMA 3R rating.

Routing Power Cables

Do not install line-side power cables in the same conduit or cable tray with load-side power cables. Also, do not route control cables through the same conduit or cable tray as power cables. Unused conduit holes must be covered with a conduit hole plug.

Routing Control Wires

A separate, smaller conduit opening is supplied for control cables. If the control cables must intersect the power cables, make sure they cross at right angles.

3.6 Control Terminals

Phase Technologies soft starters are equipped with Control Terminals that allow several control functions, including remote ON/OFF control, digital output signals, remote notification, and serial communication.

⚠ WARNING: Do not connect Control Terminals to external circuits with voltage greater than that specified for each Control Terminal in **Table 5**. De-energize the unit by disconnecting all incoming sources of power before servicing the equipment.

⚠ CAUTION: The AUX1 and AUX2 terminals are galvanically isolated, with approximately 15 V potential between them. DO NOT apply voltage to the terminals. Use dry contacts only.

Control terminals are located on the Control Board of each soft starter. **Figure 7** and **Figure 8** shows where the Control Terminals are located on the Control Board for each system. See **Table 5** for information on the function of control terminals.

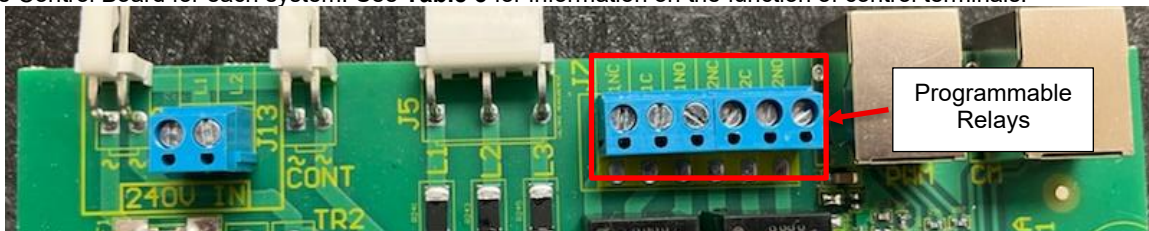

Figure 7 – Control Terminals – top of control board

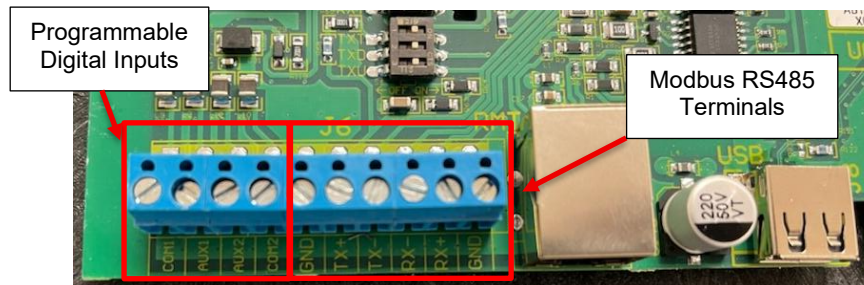

Figure 8 – Control Terminals – bottom of control board

Table 5 – Control Terminal Ratings and Descriptions

Terminal Designator	Description	Rating	Comments
AUX1	Auxiliary 1	< 15 Volts galvanically isolated	Programmable digital input. Commonly used for RUN/STOP command. See Table 14 for details.
AUX2	Auxiliary 2		
COM1	Common	-	Common for all terminals except programmable relays.
COM2			
1NO	Normally Open Relay	30 VDC or 277VAC, 10A	Relay controlled by the conditions set in Parameter 1.3.4 PROGRAM RELAY 1 . See Table 14 for programming instructions.
1NC	Normally Closed Relay		
1C	Common		Common terminal for 1NC and 1NO terminals. CAUTION: Do not use as common for other terminals.
2NO	Normally Open Relay		Relay controlled by the conditions set in Parameter 1.3.5 PROGRAM RELAY 2 . See Table 14 for programming instructions.
2C	Common		Common terminal for 2NC and 2NO terminals. CAUTION: Do not use as common for other terminals.
TX+	Transmitting Positive	< 5 Volts galvanically isolated	Connections for Modbus RTU and BACnet MS/TP. For four wire communication, wire signal wires to all four terminals.
TX-	Transmitting Negative		
RX-	Receiving Negative		
RX+	Receiving Positive		
GND	Ground		

3.7 Short Circuit Protection

Motor circuit protection for soft starters must comply with IEC 60947-4-1 standard, which defines two coordination types for soft starters: Type 1 coordination and Type 2 coordination.

Type 1 Coordination

Type 1 coordination is the basic level of short circuit protection defined in IEC 60947-4-2. Under Type 1 coordination, the soft starter and its associated protective device (typically a fuse or circuit breaker) must protect personnel and installations from danger during a short circuit condition. However, the soft starter itself may sustain damage and is not required to remain functional after the fault is cleared. Damage to the contactor or starter components is acceptable, provided that the damage does not cause risk of electric shock or fire, and the protective device successfully interrupts the fault current. After a short circuit event under Type 1 coordination, the damaged components must be inspected and may require replacement before the system can be returned to service.

Type 2 Coordination

Type 2 coordination provides a higher level of protection and operational continuity compared to Type 1. Under this coordination type, the soft starter must remain operational and undamaged after a short circuit event. This means that after the protective device clears the fault, the soft starter can typically be returned to service without replacing components. Type 2 coordination is preferred in applications where minimizing downtime is critical, as it reduces the need for immediate component replacement and allows for faster restoration of operation. The selection between Type 1 and Type 2 coordination depends on the application requirements, acceptable downtime, and cost considerations. **Type 2 coordination requires external fast acting semiconductor fuses (or similar). Phase Technologies Soft Starters do NOT adhere to Type 2 coordination with any factory shipped options.**

4 KEYPAD & DISPLAY

Before operating the motor load, several basic settings and procedures must be completed. If desired, extensive features for motor protection and special operating conditions are available through the keypad.

4.1 Using the Keypad and Display

Phase Technologies Soft Starters are capable of many advanced, easy-to-use features that allow the user to protect the motor load from damage, monitor load conditions, log motor run time, troubleshoot the system, and more. All Phase Technologies Soft Starters are equipped with an onboard display and keypad, installed on the control board.

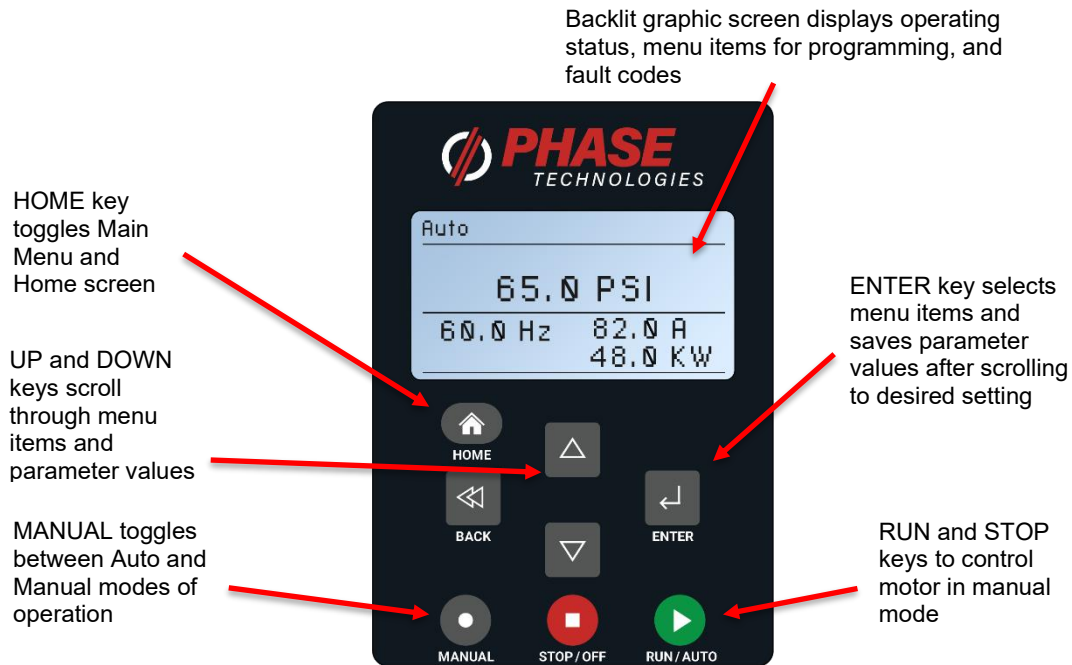

Figure 9 – Keypad and Graphic Display

Remote Display

A remote display kit can be purchased to operate Soft Starters, when installed in a panel or for a more comfortable programming experience. To use a remote display, turn the soft starter off and connect an RJ45 cable from the soft starter's control board terminal, "RMT DISP," located on the bottom of the control board, to the "BLK" terminal on the remote display. When the soft starter is powered back on, it will recognize the remote display and will automatically connect to it.

Display Modes

After one minute of keypad inactivity, the display will revert to the default display mode. Information on the display will vary based on the operating mode of the soft starter. When operating in AUTO mode, the display will indicate output kilowatts (kW) and output amps (A), or will show the status of the AUX1 and AUX2 inputs, if they are not both providing RUN commands.



Password Protecting the Keypad

The keypad can be set up with a password to prevent unauthorized changes in adjustable parameters. The parameter **1.3.17 PASSWORD SETUP (Table 14)** is used to protect the keypad. When this parameter is set to 0 the keypad is not protected. Contact customer service at 605-343-7934 if you lose or forget the password.

Keypad Display Messages

Several messages will appear on the display when the unit is initially energized. When the unit has completed its start-up routine, the default display indicating the status of the OFF, AUTO, MAN mode will appear. Start-up display messages are detailed in **Table 6** below.

Table 6 – Display of Operating Modes

MODE	DESCRIPTION
AUTO	<p>The factory default operating mode is OFF. The adjustable parameter, 1.2.1 ENABLE RESTARTS, must be set to YES to allow automatic re-starts. See Table 11 for details.</p> <p> CAUTION: In AUTO mode, the motor load will automatically run if both AUX1 and AUX2 remote switches are open. Close AUX1 or AUX2 to stop the motor or push STOP/OFF key.</p> <p> CAUTION: By default, AUX1 and AUX2 are programmed to run when closed. See 1.3.9 AUX1 SELECT and 1.3.10 AUX2 SELECT to change this setting.</p>
MANUAL	<p>In MANUAL mode the motor load is controlled by using the RUN and STOP keys, which will override all external control signals.</p> <p>Manual control of the soft starter through the keypad can be disabled through the parameter 1.3.2 DISABLE MANUAL MODE. See Table 14, for details.</p> <p> CAUTION: Operating the system in MANUAL mode on the keypad overrides signals from all external controls, including pressures switches. Operating the system in this mode may lead to dangerous operating conditions such as extreme pressure in closed plumbing systems.</p>
OFF	<p>The factory default operating mode is OFF. The adjustable parameter, 1.2.1 ENABLE RESTARTS, must be set to YES to allow automatic re-starts. To exit AUTO mode, press the STOP/OFF key. If the motor is running, it will stop. To restart the motor, revert to either AUTO mode or MANUAL mode. Certain faults can also be cleared by pressing and holding both the UP and DOWN arrow keys for one second.</p>

4.2 Keypad Main Menu Items

The HOME key toggles between the Home screen (operating status screen) and the Main Menu items. Use the UP and DOWN arrows to scroll through the Main Menu items. Press ENTER to view or edit a Main Menu item. **Table 7** contains a brief description of Main Menu items, followed by in-depth instructions on the use and function of each Main Menu item.

Table 7 – Main Menu Items

DISPLAY MESSAGE	DESCRIPTION
1 CHANGE PARAMETER VALUES	Allows the user to set values for functions such as motor overload settings, under current, time to restart after a fault, etc.
3 READ MEASURED VALUES (RMV)	Displays measured values such as output current, input voltage, load power factor, etc.
4 READ TIMERS	Records motor run time and soft starter on time.
5 RESTART LOG	A resettable fault log that records the number of times a particular fault has occurred. The number of faults counted in this log can be cleared through the CLEAR MEMORY menu.
6 FAULT LOG	Records the number of times a particular fault has occurred and records the time and date of the 20 most recent faults. FAULT LOG cannot be reset by the user.
7 CLEAR MEMORY	This function clears the Restart Log and Timers. <u>All</u> fault counters in the Restart Log will be reset to zero. If any number of automatic restarts have been allowed through parameters in the Auto Restart Parameters (See Table 13), the counter on these faults will be reset to zero.
9 SETUP WIZARD	This allows the user to quickly set up common applications, but if additional fine-tuning is needed, see lists of adjustable parameters in Section 4.9 .
11 ALARMS	A resettable log that records the number of times alarms occur. This is also where different operating conditions can be programmed to trigger a Fault or an Alarm.
12 FILE SYSTEM	Opens the menu for importing and exporting settings or reprogramming firmware.

4.3 Change Parameter Values

The Main Menu item, **1 CHANGE PARAMETER VALUES**, leads to several sub-menus that contain adjustable operating parameters. These parameters provide basic functions such as motor overload protection and advanced features that allow customized operation of the soft starter to fit the specific application.

Section 5 contains a complete list of the parameters along with a description of their function and instructions on setting them.

4.4 Read Measured Values

The display can provide a variety of measured values related to the performance of the soft starter and its load such as currents, horsepower, and power factor. To read measured values:

1. Press the HOME key to access Main Menu items, and then scroll with arrow keys until **3 READ MEASURED VALUES** appears on the display.
2. Press ENTER to access this menu item.
3. Use the UP and DOWN arrow keys to scroll through the various values that you wish to read.

Table 8 – Measured Values

DISPLAY MESSAGE	DESCRIPTION OF MEASURED VALUE
3.1 OUTPUT HP	Output measured in horsepower (HP)
3.2 OUTPUT kW	Output measured in kilowatts (kW)
3.3 OUTPUT kVA	Output measured in kilovolt amperes (kVA)
3.4 OUTPUT PF	Power factor of the motor load
3.5 INPUT VOLTAGE	Input voltage, measured in Volts AC (VAC)
3.6 I1 I2 I3	Three-phase output currents, measured in Amps (A)
3.7 MODEL NUMBER	Indicates model number of the product and the firmware version of the soft starter's digital signal processor (DSP).
3.8 AUX1 AUX2	ON/OFF status of the remote switch circuits AUX1 and AUX2
3.9 STARTUP DELAY	Displays a timer that counts down the time left to start when the soft starter is in a time delay due to a fault condition.
3.10 REAL-TIME CLOCK	Date/Time
3.11 BOOT FIRMWARE CRC	The boot loader version internal to the DSP.

4.5 Read Timers

The timer function records motor run time in hours, and the time the soft starter has been energized. There are two timers for each function, one can be reset, and one permanent. To view the timers:

1. Press MENU to scroll through menu items until **4 READ TIMERS** appears on the display.
2. Press ENTER to enter this menu item.
3. Use the up and down arrows to scroll through the clock functions.

Table 9 – Timers

TIMER	DESCRIPTION
4.1 Motor Run Time	Logs motor run time in hours.
4.2 Soft starter On Time	Logs time in hours the soft starter is energized
4.3 All Motor Hours	Logs total motor run time. Not resettable.
4.4 All Soft starter Hours	Logs total time the soft starter is energized. Not resettable.
4.5 Cycle Counters (Updated Weekly)	Logs the number of times the load has started in total, in the last year, and in the last month. Counts update once per week.
4.6 Cycle Counters (Updated Daily)	Logs the number of times the load has started in the last week, the previous day, and the current day. Counts update once per day.



Programming Tip

To reset the timers, navigate to the Main Menu item, **7 CLEAR MEMORY**, use arrow keys to select **RESET TIMERS**, and then press ENTER

4.6 Restart Log

The Restart Log records the number of times each fault has occurred. The faults counters in the Restart Log are resettable and are tied to faults that allow programmable automatic restarts. These automatic restarts are programmed through **1.2 AUTO RESTART PARAMETERS**, which is a sub-menu of the Main Menu item **1 CHANGE PARAMETER VALUES**.

For instance, in a water well pump application, it might be useful to protect the pump from dry well condition by setting the **1.1.19 UNDER CURRENT** parameter (found in the **1.1 OPERATING PARAMETERS** menu) so that the soft starter shuts down and registers a **1.1.19 UNDER CURRENT** fault in the Restart Log.

The soft starter can also be programmed to automatically restart after a delay to allow the well to recover. Both the delay time and number of restarts can be programmed in **1.2 AUTO RESTART PARAMETERS**. The Restart Log allows the user to monitor the type and number of faults that have occurred. If the number of **1.1.19 UNDER CURRENT** faults exceeds the number of automatic restarts allowed, the soft starter will remain OFF until power is cycled off and back on.

Output current (from read measured values) on each output terminal must remain below the **1.1.19 UNDER CURRENT** programmed for the time set in **1.2.2 UNDER CURRENT DELAY** (auto restart parameters, default 20s) for the soft starter to fault.

To view the Restart Log:

1. Press the HOME key, then use the UP and DOWN arrows to scroll through menu items until **5 RESTART LOG** appears on the display.
2. Press ENTER to access this menu item.
3. Use the UP and DOWN arrows to scroll through the faults.
4. The fault will appear on the first row of the display, followed by the number of times that fault has occurred.

To clear the Restart Log and reset all Auto Restart fault counters:

1. Press the HOME key, then use the UP and DOWN arrows to scroll through the Main Menu items until **7 CLEAR MEMORY** appears on the display.
2. Press ENTER.
3. Use the UP and DOWN arrows to find **7.1 CLEAR RESTART LOG**.
4. Press ENTER to clear the Restart Log and reset all Auto Restart fault counters.

CAUTION: Clearing the Restart Log through the **7 CLEAR MEMORY** menu will clear ALL faults in the Restart Log and all fault counters in the will be reset to zero.

When the soft starter has faulted and is programmed to automatically restart after a time delay, the display will count down the remaining time to start. Press and hold both the UP and DOWN arrows for one second to interrupt the countdown and start the motor.

If the soft starter has faulted and no auto restart is allowed, the display will indicate the type of fault that has occurred on the top line and the second line will read **RESTART? ENTER**. Press ENTER to clear the fault and restart the load.

The number and type of faults are also recorded in the Fault Log. In this Log each fault is recorded with a time and date stamp (up to the most recent 20 faults). The Fault Log is permanent and cannot be cleared. See the following section for more information on the Fault Log.

4.7 Fault Log

The Fault Log is a permanent record of soft starter faults. The number of faults cannot be reset by the user. Faults will be stamped with the time and date the fault occurred, up to a total of 20 times for each fault. After the 20th fault, the oldest time-stamped fault will be replaced with the most recent.

The Fault Log is a Main Menu item. Press the HOME key, then use the arrow keys to scroll until **6 FAULT LOG** appears. Press ENTER to view the list of faults, using the arrow keys to scroll through the list.



Programming Tip

A maximum of 20 time and date stamps can be applied to any given fault. After the 20th fault, the oldest fault time stamp will be erased and replaced by the most recent. The soft starter will continue to count faults up to a maximum of 9,999 for each individual fault.

4.8 Clear Memory

The **7 CLEAR MEMORY** function in the Main Menu allows you to reset the timers that record motor run time and soft starter on time, and to reset the Restart Log which counts the number of each fault.

1. Press HOME, then use the arrow keys to scroll until **7 CLEAR MEMORY** appears on the display.
2. Press ENTER to enter this menu item.
3. Use the UP and DOWN arrows to find either **7.1 CLEAR RESTART LOG** or **7.2 RESET TIMERS**.
4. Press ENTER to reset the selected function.

4.9 Setup Wizard

The Setup Wizard selection will be shown upon the first initialization of the Soft Starter and can be accessed through the keypad at any time by scrolling through the Main Menu Items to the **9 SETUP WIZARD** menu.

The Setup Wizard allows users to quickly setup commonly used control schemes. See the following table for Setup Wizard walkthrough.

The wizard will guide users through a list of commonly used parameters for the control method selected.

Using this wizard will allow adequate control of most systems, but if additional fine-tuning is needed, see lists of adjustable parameters in **Section 5**.

Table 10 – 9 Setup Wizard

PROMPT	DESCRIPTION
Press Enter to Begin	Press the "Enter" key to go through the wizard.
Motor Full Load Current	Base setting used by all other current-based parameters.
Select Preset	Starting preset for various load types. Will change several parameters to match expected load.

5 ADJUSTABLE PARAMETERS

5.1 Changing Parameter Values

 **WARNING:** When the soft starter is set to automatically restart after a fault, the output terminals can energize and the load can start without warning, exposing the user to risk of serious injury. Make certain the input is de-energized before approaching the equipment.

The **1 CHANGE PARAMETER VALUES** function allows the user to set values for a variety of functions including motor overload settings, number of restarts after a fault, and more. To change parameter values:

1. Press the HOME key until **1 CHANGE PARAMETER VALUES** appears on the display.
2. Press ENTER to access this menu item.
3. Use the UP and DOWN arrows to scroll through the sub-menu to find the item desired, then press ENTER. See **Table 12** through **Table 14** for a list of parameters.
4. Use the UP and DOWN arrow keys to scroll to the desired parameter, press ENTER, then use the UP and DOWN arrows to change the value.
5. When the value you want appears on the display, press ENTER to set the value or BACK to cancel.

5.2 Restore Default Parameter Settings

 **CAUTION:** The soft starter output must be stopped before resetting. Failure to do so may result in damage to the soft starter or equipment.

To restore **ALL** adjustable parameters to their default value, press and hold the BACK and ENTER keys at once and hold for three seconds. If a password is configured, you will be prompted to enter the password first. You will then be prompted to press ENTER for yes or BACK for no.

 **CAUTION:** To reset an individual parameter to its default value, you must refer to the appropriate table of Adjustable Parameters, find the default value, re-enter that value and save it. See **Section 5** for a complete list of parameters, their description, and default/minimum/maximum values.

5.3 Auto Restarts

The soft starter can be programmed to automatically restart after certain faults. Using the **1.2 AUTO RESTART PARAMETERS** (**Table 13**), you can set a time delay before the soft starter starts after a fault and select the number of automatic restarts allowed before the unit will remain OFF after a fault.

Example: You wish to allow 10 automatic restarts after a fault but want the soft starter to wait for one hour, to allow the well to recover, before restarting. When the soft starter is counting down the time to restart after a fault, the display will indicate the time until restart in seconds.



Programming Tip

To interrupt the countdown and allow a restart, push and hold both the UP and DOWN keys for one second. The load will start immediately.

When the soft starter reaches the limit of faults set by the adjustable parameter, it will remain OFF and the display will indicate the type of fault on the top line. The second line will read **RESTART? ENTER**. Press ENTER to clear the fault and restart the load. The fault counters in the **5 Restart Log** will all be reset to zero. See **Section 4.6** for more information. Some faults do not allow auto restart. The display will read **NO AUTO RESTART**. See **Section 4.7, Fault Log**, for more information.

5.4 All Parameters List

To aid in troubleshooting, a numbered parameter list containing all parameters is available for use. Some parameters are visible that are not always used. In this case, the word “Disabled” is shown, and programming functionality is disabled for that parameter. To access **1.9 ALL PARAMETERS**:

1. Press the HOME key to access Main Menu items, and then scroll with arrow keys until **1 CHANGE PARAMETER VALUES** appears on the display.
2. Press ENTER to access this menu item.
3. Use the UP and DOWN arrow keys to scroll to **1.9 ALL PARAMETERS**.
4. Press ENTER to access this menu item.

5.5 Changed Parameter List

This is a list of all parameters that have been changed from their default values. This allows for quick and easy programming of previously changed parameter values. The total number of changed parameters and the index of changed parameters will be displayed at the top of the screen. If there are no changed parameters, then “No Changed Parameters” will be shown. To access

1. Press the HOME key to access Main Menu items, and then scroll with arrow keys until **1 CHANGE PARAMETER VALUES** appears on the display.
2. Press ENTER to access this menu item.
3. Use the UP and DOWN arrow keys to scroll to **1.10 CHANGED PARAMETERS**.
4. Press ENTER to access this menu item.

5.6 File System

Phase Technologies Soft starters are equipped with a USB terminal that can be used to Import and Export Parameters as well as install firmware upgrades or custom firmware. Firmware files will be .hex format and parameter data files will be saved as a .CSV file.

⚠ CAUTION: USB device must be inserted while soft starter is **powered off**. Failure to do so may result in injury or damage to the product. Power may be applied while USB device is inserted, but the system must be powered off before removing the USB from the terminal. Always turn power to the system off and wait for the discharge time specified on the front label to allow the DC bus to discharge before working in the enclosure.



Hardware Tip

To use File System, the chosen USB storage device must be configured as either FAT or FAT32 and the maximum capacity must be 32 GB or less.

With the soft starter powered off, locate the USB terminal on the control board. **Figure 10** below shows the USB terminal on a control board. Insert the USB device into the terminal, replace the enclosure cover, and apply power to the soft starter.

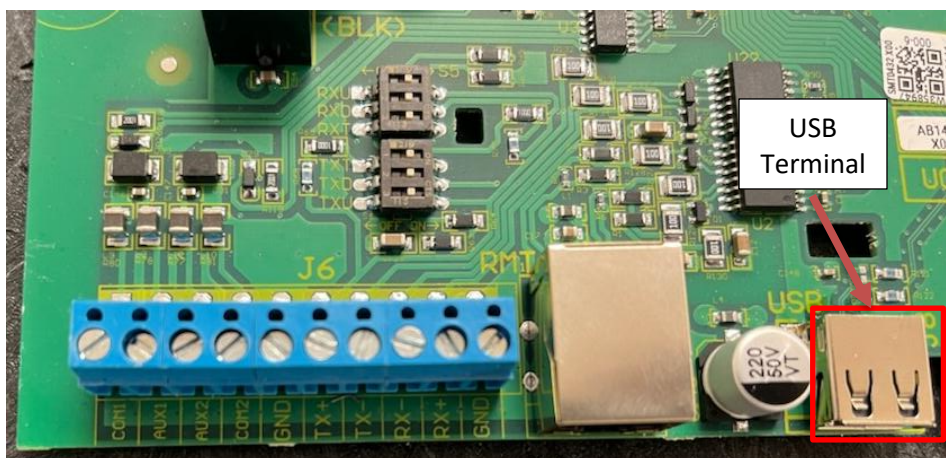

Figure 10 – USB Terminal on Alpha Soft starter Control Board

Export Parameter Data

1. From the HOME screen, press ENTER, then scroll down to **12 FILE SYSTEM** and press **ENTER**.
2. Use the up and down arrows to select **12.1 EXPORT PARAMETER DATA** on the display and press **ENTER**.
3. Parameter data will be exported to a .CSV file on the USB device. If the export was successful, the display will show **EXPORT SUCCESSFUL**. If the screen shows **EXPORT UNSUCCESSFUL**, cycle power and retry steps 1 – 3.
4. The file can now be used to import parameters to another Soft Starter. The file can also be opened on a personal computer to view and troubleshoot parameter settings.

The file format of the parameter data will be a .CSV file, which can be opened by Microsoft Excel. **Table 11** below shows the format of the exported parameter data. Information about the soft starter model and the export date will be shown in the top left. Next, Adjustable Parameters will be listed, along with their current, default, minimum, and maximum values. A column on the far right will denote whether the parameter has been changed or if it remains at the default setting.

Table 11 – Exported Parameter Data

Model Info: SS034R SW 1.0.1.0					
Family: Soft Starter					
Firmware Family: Production					
Date/Time: 25/20/2064 33:83:24					
Boot Firmware: 01.00					
Boot CRC: 0xB63E5EFF					
All Parameters					
Name	Current	Default	Minimum	Maximum	Changed
Overcurrent Limit	30	30	3	32	
Dry Well Current	0	0	0	30	
Current Unbalance	80	80	1	100	
Restart Delay	60	60	0	9999	

Measured Parameters will be the next set of data shown. These are values measured at the time of data export. Continuing down, Changed Parameters will be shown followed by the number of times the control board has been reprogrammed via USB device and a software version history. Last, the Fault Log will show any stored faults and their associated date and time stamp.

Import Parameter Data

The exported Parameter Data files can be used to apply the same parameters to other soft starters. This will exclude any parameters that are model-specific, such as **1.1.20 OVERCURRENT LIMIT**. To export parameter data:

1. From the HOME screen, press ENTER, then scroll down to **12 FILE SYSTEM** and press ENTER.
2. Use the up and down arrows to select **12.2 IMPORT PARAMETER DATA** on the display and press ENTER.
3. Next, select whether you want to import Model-specific data, which includes **Overcurrent Limit** and **Under Current Limit**.
4. Use the Up and Down arrows to select the file of parameters to be applied and press ENTER.
5. If the parameter import is successful, the display will show **IMPORT SUCCESSFUL**. If the screen displays **IMPORT UNSUCCESSFUL**, cycle power and retry steps 1 – 5.

Reprogram Firmware

If needed, the USB terminal can be used to reprogram the firmware of the SOFT STARTER for software upgrades or custom features.

The firmware version of Phase Technologies soft starters can be found by pressing ENTER on the home screen and then scrolling up or down to **3 READ MEASURED VALUES** and pressing ENTER. Under **3 READ MEASURED VALUES**, there will be a heading called **3.18 MODEL NUMBER**, which will show the SOFT STARTER model and current firmware versions.

To reprogram a Phase Technologies Soft Starter:

1. Turn power to the system OFF and insert the USB device into the USB port at the top of the INTF control board.
2. Reapply power to the soft starter.
3. From the HOME screen, press ENTER, then scroll down to **12 FILE SYSTEM** and press ENTER.
4. Use the up and down arrows to select **12.5 REPROGRAM FIRMWARE** on the display and press ENTER.
5. Use the up and down arrows to select the “INTF” firmware file for reprogramming and press ENTER.
6. If the file chosen contains the proper firmware for the SOFT STARTER model, reprogramming will begin. Reprogramming firmware will take several minutes. If the LEDs, labeled TX and RX, on the INTF board are flashing, that means that the reprogramming process is underway.
7. If the reprogram is successful, the display will show **SUCCESSFUL, PRESS ENTER TO RESET**.
8. If the display shows **UNSUCCESSFUL**, cycle power and retry steps 1 – 5.
9. Press **ENTER** and the soft starter will reboot with the new software version.

The firmware version can be verified by going to **3 READ MEASURED VALUES** and scrolling to **3.18 MODEL NUMBER**.

5.7 Menu Structure Overview

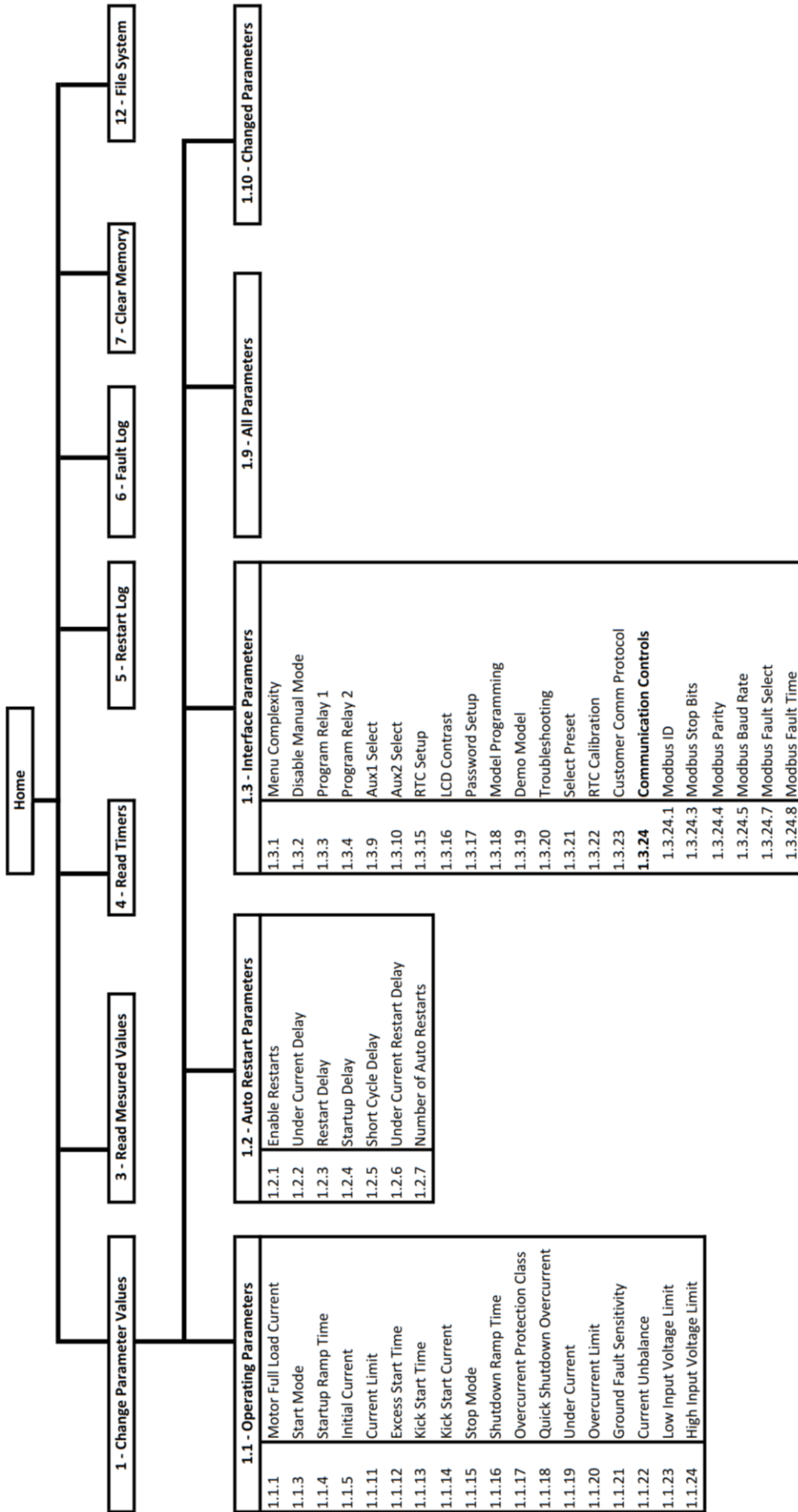

5.8 Parameter Tables

Table 12 – 1.1 Operating Parameters

\$ - Parameters are only visible when **1.3.2 MENU COMPLEXITY** is set to **STANDARD**.

@ - Parameters are only visible when **1.3.2 MENU COMPLEXITY** is set to **ADVANCED**.

DISPLAY MESSAGE	DESCRIPTION	DEFAULT [UNITS] (MIN - MAX)
1.1.1 Motor Full Load Current	Sets the rated full-load current of the connected motor. This value can be found on the motor nameplate and is essential for proper current monitoring and protection settings.	Model Specific
1.1.3 Start Mode	Select the method of motor starting. Options include: current ramp, constant current, bypass, and user-defined, which affect how the motor accelerates during startup.	Constant Current
1.1.4 Startup Ramp Time	The duration, in seconds, over which current is increased during motor starting.	10 sec (1 - 120)
1.1.5 Initial Current	Sets the initial current level, as percent of 1.1.1 MOTOR FULL LOAD CURRENT , at the beginning of the startup sequence. This affects how gently the motor begins turning from standstill.	0% (0 - 600)
1.1.11 Current Limit	Specifies the maximum current, as percent of 1.1.1 MOTOR FULL LOAD CURRENT , allowed during startup. Limits excessive inrush current to protect the motor and power system.	350% (100 - 600)
1.1.12 Excess Start Time	Determines the maximum time, in seconds, the motor is allowed to remain in the startup phase. If exceeded, a fault is triggered to prevent overheating and overloading.	20 sec (1 - 120)
1.1.13 Kick Start Time	Specifies the time duration, in seconds, for an initial high current "kick" to help start motors with high static friction or load inertia.	0 sec (0 - 2,000)
1.1.14 Kick Start Current	Defines the current level, as percent of 1.1.1 MOTOR FULL LOAD CURRENT , used during the kick start period. This parameter is useful for applications requiring a strong initial torque.	500% (0 - 600)
1.1.15 Stop Mode	Selects the method used to stop the motor. Options include coast to stop or voltage ramp, depending on application requirements.	Coast to Stop
1.1.16 Shutdown Ramp Time	Defines the time, in seconds, over which the motor decelerates when ramp to stop is selected, helping to reduce mechanical wear and stop the motor smoothly.	1 sec (1 - 120)
1.1.17 Overcurrent Protection Class	Sets the thermal overload curve used to protect the motor based on NEMA Class standards (e.g., Class 5, 10, 20, or 30). Determines how quickly the system responds to overcurrent conditions.	Class 10
1.1.18 Quick Shutdown Overcurrent	Defines a current threshold that, if exceeded rapidly, will trigger an immediate shutdown to prevent damage from severe overcurrent events.	500% (1 - 600)
1.1.19 Under Current	Specifies the minimum operational current level. If the motor current drops below this threshold during operation, an undercurrent fault is triggered, indicating potential load loss or disconnection.	Disabled (1 A - 100)
1.1.20 Overcurrent Limit	Sets the absolute maximum current, as percent of 1.1.1 MOTOR FULL LOAD CURRENT , that the system will allow before initiating a protective shutdown or fault.	105% (1-600)
1.1.21 Ground Fault Sensitivity	Adjusts the sensitivity of ground fault detection – higher being more sensitive. Higher sensitivity allows the system to detect smaller leakage currents. The default value of 0 disables this protection.	0 (0 - 9)
1.1.22 Current Unbalance	Defines the allowable percentage difference between phase currents. An imbalance beyond this limit may indicate issues such as phase loss or motor faults.	20% (1 - 100)
1.1.23 Low Input Voltage Limit	Sets the minimum acceptable line voltage level. If voltage drops below this threshold, the starter may inhibit operation or issue a fault to protect the motor.	100 V (100 - 530)
1.1.24 High Input Voltage Limit	Specifies the maximum allowable line voltage. If voltage exceeds this value, the starter will protect the motor by preventing startup or triggering a shutdown.	530 V (100 - 530)

\$ - Parameters are only visible when **1.3.2 MENU COMPLEXITY** is set to **STANDARD**.

@ - Parameters are only visible when **1.3.2 MENU COMPLEXITY** is set to **ADVANCED**.

Table 13 – 1.2 Auto Restart Parameters

DISPLAY MESSAGE	DESCRIPTION	DEFAULT [UNITS] (MIN - MAX)
1.2.1 Enable Restarts	Allows the soft starter to automatically restart after a fault using last known run command. NO = no auto restarts and unit will initialize in OFF mode YES = Auto mode on initialization and auto restarts allowed	Yes
1.2.2 Under Current Delay	Time 1.1.10 UNDER CURRENT is allowed before unit trips.	20 sec (0 - 2h 46m 39s)
1.2.3 Restart Delay	Delay before unit restarts after any fault trip other than Under Current. See 1.2.6 UNDER CURRENT RESTART DELAY for more information.	15 sec (0 - 2h 46m 39s)
1.2.4 Startup Delay	Delay before a restart after an input power OFF/ON cycle.	0 sec (0 - 2h 46m 39s)
1.2.5 Short Cycle Delay	Delay after motor goes from ON to OFF. Prevents the starter from engaging the motor when it is spooling down during coast-to-stop operation. Display will count down seconds until RUN.	3 sec (3 - 10 min)
1.2.6 Under Current Restart Delay	Delay before unit restarts after an UNDERCURRENT fault. Commonly used to allow a well to recharge after a dry well condition.	0 sec (0 - 7 days)
1.2.7 Number of Auto Restarts	Number of automatic restarts allowed after a fault trip.	10 (1 - 9,999)

\$ - Parameters are only visible when **1.3.2 MENU COMPLEXITY** is set to **STANDARD**.

@ - Parameters are only visible when **1.3.2 MENU COMPLEXITY** is set to **ADVANCED**.

Table 14 – 1.3 Interface Parameters

DISPLAY MESSAGE	DESCRIPTION	DEFAULT [UNITS] (MIN - MAX)
1.3.1 Menu Complexity	Determines what parameters are shown or hidden. Simple will be adequate for most applications but more complex programming requires additional parameters to be visible. Parameters visible in Standard mode will be followed by "\$" on the display. Parameters visible in Advanced mode will be followed by "@" on the display.	Standard
1.3.2 Disable Manual Mode	Disables manual operation of the soft starter through the keypad. Operating states are limited to AUTO and OFF. YES = MANUAL mode disabled.	No
1.3.3 Program Relay No 1	Programmable normally open / normally closed relay. Control Terminals 1NC, 1NO, and COM. The relay can be programmed to change state for the following conditions: 0 = System Fault: State will change when soft starter faults. 1 = Pump Fault: e.g. motor overload, under current, etc. 2 = Modbus Control: Customer Modbus is controlling the relay. Modbus Control commands will override current settings except when configured to state 5. 3 = Output Active: Relay activates when SOFT STARTER is starting or started. 4 = Damper: Relay activates when AUX1 is closed in the Auto runmode. 5 = Jockey Pump: Relay activates when SOFT STARTER is starting or started. This setting is only available for Program Relay 1.	0 - System Fault
1.3.4 Program Relay No 2	Programmable normally open / normally closed relay. Control Terminals 2NO, and COM. See Parameter 1.3.3 PROGRAM RELAY 1 above for description of values.	3 - Output Active
1.3.9 Aux 1 Select	Programmable digital inputs. Generally used for motor Run/Stop control. 0 = RUN/STOP (On = RUN, Off = STOP) 1 = RUN/STOP (Off = RUN, On = STOP) 2 = Always in Run Mode 3 = Latching Relay. When the connection between the AUX terminal and COM is opened the soft starter will stop the motor and display a fault on the screen. The motor will remain stopped even if the connection is closed. The fault must be cleared by pressing the ENTER key. 4 = Reverse Latching Relay. Identical operation to 3 except open and closed states are reversed. 5 = Fireman's Override. Only available in Aux 2 Select. Forces the soft starter into RUN mode when closed. All faults are ignored until open. STOP/OFF button can be used to override behavior and force the soft starter to stop.	0 - Closed=Run
1.3.10 Aux 2 Select		0 - Closed=Run
1.3.15 RTC Setup	Real-Time Clock MO/DD/YR H:M:SS Enter button moves the character to the right, use UP and DOWN keys to select the number.	-
1.3.16 LCD Contrast	Used to adjust the contrast of the graphic display.	40 (30 - 60)

DISPLAY MESSAGE	DESCRIPTION	DEFAULT [UNITS] (MIN - MAX)
1.3.17 Password Setup	Allows keypad function to be password protected. When keypad is locked, it will prompt for a user-defined four-digit password. A parameter value of "0000" disables password protection. Each digit can go from 0 to F: 0 - 9, and A - F. Press enter to select the next digit. Setting will not change after a factory reset.	No Default
1.3.18 Model Programming	In rare instances, a model will need to be changed. This SHOULD ONLY be used under the direction of Phase Technologies.	Set by Factory
1.3.19 Demo Model	Reserved for Factory Use.	Reserved for Factory Use
1.3.20 Troubleshooting	Used to access Advanced Parameters and clear memory.	Reserved for Factory Use
1.3.21 Select Preset	Sets the characteristics to optimize for the load being run. Options are: Centrifugal Pump Submersible Pump Damped Fan Undamped Fan Screw Compressor Reciprocating Compressor Conveyor Rotary Crusher Jaw Crusher See Section 6.7 for more details.	Damped Fan
1.3.22 RTC Calibration	Used to adjust the RTC drift by seconds per day.	5 (-31 - 31)
1.3.23 Customer Comm Protocol	Used to select the desired communication protocol. Options are: Modbus RTU, BACnet MS/TP.	Modbus RTU
1.3.24 Communication Controls	Press ENTER to see the following parameters related to Modbus communication.	
1.3.24.1 Modbus ID	Address of the soft starter for a Modbus network.	1 (1 - 247)
1.3.24.3 Modbus Stop Bits	Number of bits transmitted after each character to detect the end of the character.	1 (1 - 2)
1.3.24.4 Modbus Parity	Sets how the parity of the character's data frame is set.	None
1.3.24.5 Modbus Baud Rate	Serial baud rate or the rate at which information is transferred.	19200 (2400 - 57600)
1.3.24.7 Modbus Fault Select	Select how the soft starter responds when serial communication is lost. Options are disabled, to fault, or stop the output of the SOFT STARTER without faulting.	Disabled
1.3.24.8 Modbus Fault Time	In seconds. Select how long serial communication loss persists before Modbus Fault Selection state takes effect.	0 sec (0 - 5 min)

\$ - Parameters are only visible when **1.3.2 MENU COMPLEXITY** is set to **STANDARD**.

@ - Parameters are only visible when **1.3.2 MENU COMPLEXITY** is set to **ADVANCED**.

6 OPERATION

6.1 Commissioning the Unit

It is always advisable to check the operating status of the soft starter and its load before commencing regular operation.

Initial Operation

Verify the following:

1. The unit is securely attached to the proper mounting surface.
2. The unit's input terminals are connected to an appropriate power source.
3. An appropriately rated motor is connected to the output terminals.
4. The motor is secured and properly mounted.

Setup Wizard

Upon the first initialization of the unit (or after restoring factory defaults of all parameters) the soft starter will prompt the user to enter a Setup Wizard. The Setup Wizard allows users to quickly setup common applications. The wizards will guide users through a list of commonly used parameters for the application selected. Use the UP and DOWN keys to change the selected parameter, then press ENTER to set the parameter and proceed to the next.

6.2 Soft Starter Setup Procedure

1. If remote or automatic ON/OFF function is required, connect remote switch leads to the AUX1 and COM terminals. An additional remote switch or jumper wire may be connected to the AUX2 and COM terminals. The **AUX1 to COM and AUX2 to COM jumper wires will already be installed by the factory, remove as needed for pressure switches or remote ON/OFF switches.**
2. Apply power to the input terminals of the soft starter by turning on the input circuit breaker or disconnect switch.
3. The graphic display will scroll through several start-up sequence messages.
4. If the **1.2.1 ENABLE RESTARTS** parameter is set to allow restarts, the soft starter will initialize in AUTO mode and the motor will run when control signals call for a motor run condition. To prevent the motor from running at start-up, immediately after initialization, press the STOP/OFF key until **OFF** appears on the display or open AUX1 or AUX2.
5. Confirm that the unit has properly energized, and the display indicates the OFF mode.
6. The Setup Wizard requires both 1.1.1 MOTOR FULL LOAD CURRENT and 1.1.3 START MODE to be set upon first initialization.
7. Use the keypad and display to navigate to **1.2 AUTO RESTART PARAMETERS** → **1.2.1 ENABLE RESTARTS** This parameter enables the soft starter to initialize in AUTO mode and to restart automatically after a fault. Factory default allows auto restarts.
8. Push the MANUAL key until **MANUAL** appears on the display for manual mode, then push RUN to start the motor. In manual mode, the RUN key will override an open AUX terminal or other external control signal. Push the STOP key to stop the motor in manual mode.

 **CAUTION:** In manual mode, pushing the RUN key will override all external control signals, including constant pressure sensors. Dangerous pressure rise in closed plumbing systems is possible.
9. The motor will start with the default acceleration ramp time.
10. Confirm that the motor rotation is correct. Swapping any two of the output leads will reverse the motor rotation.
11. After initial power-up, use the keypad and display to navigate to **1 CHANGE PARAMETER VALUES** to set any other adjustable parameters you wish to be different from the factory defaults.

6.3 Start Modes

Constant Current: this is the standard start mode for soft starters where the current ramps from 0 to full load until the motor has reached full speed. This mode should be used in applications where the current must be kept below a certain level.

Current Ramp: this mode ensures that current stays below a specified starting level for a period of time. It can be useful for applications when the load varies between starts such as conveyors, when pumps need to run in order to build pressure slowly, or when the supplied electricity is limited such as when powered by a generator.

Bypass: this mode bypasses the soft starter and simply closes a contactor to start a motor across-the-line. This should be used if the electronics of the system have been damaged or if soft starting isn't needed.

User Defined: this mode is similar to **Current Ramp** but allows the operator to define their own starting profile using parameters **1.1.6 START UP POINT 1 TIME**, **1.1.8 START UP POINT 2 TIME**, **1.1.10 START UP POINT 3 TIME**, **1.1.7 START UP POINT 1 CURRENT**, **1.1.9 START UP POINT 2 CURRENT**, and **1.1.11 CURRENT LIMIT**.

6.4 Ground Fault Sensitivity

These soft starters are equipped with a feature to detect a fault between any of the output lines and earth. If a ground fault is strong enough to trigger the parameter **1.1.12 GROUND FAULT SENSITIVITY**, the soft starter will not run or will immediately stop. However, this does not protect the soft starter from damage in all situations. **If a ground fault occurs, immediately disconnect the input power!** If a megger does not indicate a ground fault, the sensitivity of the ground fault detection may need to be reduced by reducing the value of parameter **1.1.12 GROUND FAULT SENSITIVITY**.

⚠ CAUTION: Before the motor is connected to the output terminals, check all output lines for line-to-ground faults using a megger. There is a direct path through the soft starter circuitry for ground fault currents that can be triggered when power is applied to the input terminals, even though the output switches are not activated. These currents can cause serious damage to soft starter circuitry and are not covered under warranty.

⚠ WARNING! The default operating mode when the unit is energized is OFF. If the parameter ENABLE RESTARTS has been set to allow restarts, the unit will energize in AUTO mode. If the external controls are calling for a motor run condition, the motor will start. Make sure either external controls are off before energizing the input, or as soon as the unit has initialized, push the STOP/OFF key until **OFF** appears on the display. Refer to **Section 4.1, Using the Keypad and Display**, for instructions on operating the keypad.

6.5 Motor Overload Protection

These soft starters are equipped with adjustable solid-state motor overload protection. Protection is based on a trip curve selected using parameter **1.1.17 OVERCURRENT PROTECTION CLASS**. Motor overload settings are selected by navigating to the appropriate menu item using the keypad and display.

Thermal Memory and Thermal Memory Retention

The motor overload protection is equipped with thermal memory and thermal memory retention capabilities.

Thermal Memory is the ability of an overload protective system to approximate the heating cooling of a protected motor during operation.

Thermal Memory Retention maintains the thermal memory upon shutdown or power loss. This includes retention of the last thermal value and may include an ongoing reduction of this thermal value to reflect the cooling of the motor. This information will be used by the overload protective system to approximate the thermal state of the motor upon restart.

⚠ CAUTION: Do not attempt to restart the motor immediately after a motor overload fault. The motor overload protection system uses a timer to approximate motor cooling and may trigger an immediate overload fault if the motor is restarted too soon.

If the soft starter loses power immediately after a motor overload fault, it will not begin counting down the time that approximates motor cooling until the soft starter is energized. If the soft starter faults with a motor overload, it may be necessary to allow time for this countdown before the motor is operated even though the motor has been off for an extended period.

Setting Motor Overload Protection with Keypad

To set motor overload protection with the keypad, navigate to the Main Menu item **1 CHANGE PARAMETER VALUES** → **1.1 OPERATING PARAMETERS** → **1.1.20 OVERCURRENT LIMIT**.

6.6 Start-Up and Shut-Down Ramp Times

Ramp times and profiles are adjustable by changing Operating Parameters through the keypad and text display. The values for **1.1.4 STARTUP RAMP TIME**, **1.1.16 SHUTDOWN RAMP TIME**, and **1.1.15 STOP MODE** are determined based on the selection of **1.3.21 SELECT PRESET**. See the next section for details.

6.7 Select Preset

Parameter **1.3.21 SELECT PRESET** will change several operating parameters to tune the soft starter for various applications. The table below shows the settings for each Preset.

Table 15 – Preset Parameters for Various Applications

Preset	Start Mode	Startup Ramp Time (s)	Stop Mode	Shutdown Ramp Time (s)	Excess Start Time (s)	Overcurrent Protection Class	Current Limit (%FLA)
--------	------------	-----------------------	-----------	------------------------	-----------------------	------------------------------	----------------------

Centrifugal Pump	Current Ramp	10	Voltage Ramp	15	20	Class 10	350
Submersible Pump	Current Ramp	5	Coast to Stop	N/A	20	Class 10	350
Damped Fan	Constant Current	N/A	Coast to Stop	N/A	20	Class 10	350
Undamped Fan	Current Ramp	20	Coast to Stop	N/A	30	Class 20	350
Screw Compressor	Constant Current	N/A	Coast to Stop	N/A	20	Class 10	400
Reciprocating Compressor	Constant Current	N/A	Coast to Stop	N/A	20	Class 10	450
Conveyor	Constant Current	N/A	Voltage Ramp	10	20	Class 10	400
Rotary Crusher	Constant Current	N/A	Coast to Stop	N/A	30	Class 20	400
Jaw Crusher	Constant Current	N/A	Coast to Stop	N/A	40	Class 30	450

7 TROUBLESHOOTING

This section provides information on fault codes and troubleshooting tips for potential system problems.

 **WARNING!** In some instances, the unit will shut down, then automatically restart when conditions allow. Always disconnect input power from the unit and wait for internal electrical charges to dissipate before performing service on the unit or its connected loads.

 **WARNING:** Risk of electric shock. De-energize the unit by disconnecting all incoming sources of power, then wait for the time specified on the soft starter warning label, before servicing the equipment.

 **HIGH VOLTAGE:** This equipment is connected to line voltages that can create a potentially hazardous situation. Electric shock could result in serious injury or death. This device should be installed and serviced only by trained, licensed, and qualified personnel. Follow instructions carefully and observe all warnings.

Always check the display for fault codes if the soft starter or its load is not operating. Disconnecting the input power could potentially clear any fault code indication, possibly losing valuable information for troubleshooting.

7.1 Fault Codes

Fault codes are indicated on the graphic display. See

Table 16 for a list of fault codes.

The soft starter can be programmed to automatically restart after certain faults and a time delay can be programmed before the restart is allowed. To interrupt a time delay countdown and allow auto restart, press both arrow keys on the keypad and hold for one second. The load will start immediately. The Restart Log is a resettable fault log that can be used to monitor faults that allow auto restart. Use the Clear Memory function to reset the Restart Log and set all fault counters to zero. See **Section 4.2**, Keypad Main Menu Items, for more information on Restart Log and Clear Memory function.



 **WARNING:** Certain faults do not allow an auto restart. These faults generally indicate the possibility of damage to the soft starter and/or the load or indicate the possibility of a dangerous condition. When this type of fault occurs, the display will read **NO AUTO RESTART**. Refer to

Table 16, *Fault Codes*, to determine if the fault allows an auto restart. The number 1 in the notes column indicates that auto restart is not allowed. When this type of fault occurs, contact the factory for assistance before restarting or troubleshoot the system thoroughly. **These faults can be cleared only by cycling input power OFF/ON or by pressing both arrow keys for 3 seconds.**

 **WARNING:** Unit may restart automatically without warning after a fault when operating conditions permit. Make certain input power is disconnected before servicing the unit or its connected loads.

7.2 Clearing a Fault

If the unit is programmed to automatically restart after a particular fault, the display indicates that the unit will restart and will count down the seconds remaining to restart on the display. The countdown can be interrupted by pressing and holding the UP and DOWN arrow keys. The load will immediately restart.

For faults that allow an automatic restart, the default number of restarts after a fault is zero. If the end user desires the unit to automatically restart after a fault, the number of restarts allowed and the time between fault and restart must be programmed under **1.2.7 NUMBER OF AUTO RESTARTS**.

If the soft starter has exceeded the programmed number of auto restarts, or if auto restarts have not been enabled, the display will indicate the fault on the top line and the second line will read **RESTART? ENTER**. Press ENTER to clear the fault and restart the load. The fault counters in the Restart Log will all be reset to zero. See **Section 4.6**, *Restart Log*, for more information.

The **1.2.1 ENABLE RESTART** parameter allows the soft starter to restart automatically after a fault. This parameter also enables to soft starter to initialize in AUTO mode when the input power has been cycled OFF/ON and the soft starter is energized. The factory default setting allows auto restarts. See **Table 14** for more information.

Certain faults do not allow an auto restart. These faults generally indicate the possibility of damage to the soft starter and/or the load or indicate the possibility of a dangerous condition. When this type fault occurs, the display will read **NO AUTO RESTART**. When this type fault occurs, contact the factory for assistance before restarting or troubleshoot the system thoroughly. **These faults can be cleared only by cycling input power OFF/ON or by holding the UP and DOWN arrow keys for 3 seconds.**

There are several conditions where the soft starter will indicate a fault, but the fault will not be recorded in the fault log. These faults occur only when the soft starter is energized from utility mains and is initializing. If any condition including ground fault, pre-charge fail, high input voltage or low input voltage is detected, the display will indicate the fault and wait for the condition to resolve before entering normal

operating mode. If these conditions occur after the soft starter has initialized, a fault will be logged and can be cleared in the normal manner.

⚠ WARNING: The soft starter may start automatically without warning when operating conditions permit. Make certain input power is disconnected before servicing the unit or its connected loads

Table 16 – Fault Codes

MESSAGE	DESCRIPTION / COMMENTS	PARAM RELATED (1)	NO AUTO RESTARTS (2)
Input 1PH Fault	Indicates a loss of phase on the input 3-phase lines, or severe voltage unbalance.		
Alarm Fault	Triggered when an alarm occurs that has been set to Fault via the 11 ALARMS menu.	X	
AUX1 Latch Fault	Switch connected to AUX1 input has closed. Soft starter will remain off until fault is cleared. See parameter 1.3.9 AUX 1 SELECT .	X	X
AUX2 Latch Fault	Switch connected to AUX2 input has closed. Soft starter will remain off until fault is cleared. See parameter 1.3.10 AUX 2 SELECT .	X	X
Comm Error	Interface and Drive boards are unable to communicate or serial communication is not functioning properly. Check RJ45 connections between boards.	X	
Current Unbalance	Motor current unbalance has exceeded the 1.1.22 CURRENT UNBALANCE limit. Check motor load for normal operation. Fault can be bypassed by increasing parameter 1.1.22 CURRENT UNBALANCE .	X	
Excess Start Time	Indicates that the soft starter has not been able to reach full voltage within the time defined by 1.1.12 EXCESS START TIME .	X	
Ground Fault	A fault between an output line and earth has been detected. Immediately disconnect input power and check output lines with a megger to verify fault. The sensitivity of fault detection can be adjusted by the parameter 1.1.21 GROUND FAULT SENSITIVITY .	X	X
High Input Voltage	Input voltage has exceeded the following levels for 10 seconds: 160VAC for 115V systems, 260VAC for 230V systems. Reduce input voltage.	X	
Invalid User Defined Settings	Triggered when user defined settings are incompatible. Check settings that have been changed from default or the unit can be reset to factory defaults by pressing and holding BACK and ENTER for three seconds.	X	
Low Input Voltage	Input voltage has fallen below a level for safe operation of the soft starter. Will trip on startup if input voltage is below 90VAC for 115V systems or below 180VAC for 230V systems.	X	
Motor Overload	Output current has exceeded the value set by parameter 1.1.20 OVER CURRENT LIMIT . Check motor load.	X	
Output CM Connection Fault	Cables to output current measurement (CM) boards disconnected. Power system down and check cable to output CM board.		X
Output Overload	Indicates a large and sudden overcurrent on the output module. Check motor circuit for faults. The overcurrent may be of a very short duration that cannot be captured by amp meters.	X	
Under Current	Motor current has fallen below the value set by parameter 1.1.19 UNDER CURRENT . Commonly used to detect a dry well condition.	X	

1 = Fault may be related to an adjustable parameter. Always check the value of the parameter to eliminate nuisance tripping.

2 = No automatic restarts allowed. The soft starter has shut down due to a potentially dangerous condition. Soft starter will remain OFF until fault is cleared. Turn power off and troubleshoot the system before restarting.

7.3 Fault Log

The Fault Log records the number of times a particular fault has occurred. To access the Fault Log, press the MENU key until the Main Menu item, **6 FAULT LOG**, appears.

Press ENTER key to access the list of faults. The Fault Log will continue to log the number of faults that have occurred until it is reset through the Main Menu item **5 RESTART LOG** or **7 CLEAR MEMORY**. The Fault Log is not to be confused with the restart counter. The restart counter is associated with the automatic restart function and is reset whenever the input power is cycled OFF/ON.

Table 17 – Troubleshooting

PROBLEM	POTENTIAL CAUSE	SOLUTION
Unit does not power up	Circuit breaker tripping	If incoming circuit breaker continually trips when SOFT STARTER starts, the breaker and cable sizes should be sized by a certified electrician. Consider increasing breaker size.
Motor not running	Is a fault code indicated?	Based on the fault code, resolve any factors that are likely causing the fault. Clear the fault by pressing ENTER on the keypad or by cycling input power OFF/ON.
	Are the remote AUX switches closed?	Check the status of the switches or jumpers connected to AUX1 and AUX2 on the Control Terminals. The LCD display indicates the status of AUX terminals in the default display mode. All AUX terminals must be set to ON for the motor to run in AUTO mode.
	Are the signals to the Control Terminals corrupted?	Shielded cable is required for AUX terminal switch leads longer than 20 ft. Regular wire will induce capacitance in the line and corrupt control signals. Shielded cable is recommended for all control signal cables.
	Is the keypad in MAN or OFF mode?	The keypad will override signals on the Control Terminals when MANUAL mode is selected. Keypad must be in AUTO mode for external control signals to control the motor.
	Are the input terminals energized?	Check the input circuit breaker and fuses.
Motor is turning the wrong direction	Phase sequence on output terminals U, V, W is out of order	Swap any two of the three motor leads on the output terminals OR use parameter 1.1.6 REVERSE ROTATION via keypad.
Real Time Clock (RTC) clearing or not providing fault time stamps	Dead battery	Replace CR2032 battery, located on the Interface control board to the left of the graphic display.

8 ROUTINE INSPECTION AND MAINTENANCE

The unit should be inspected and cleaned at least annually or more frequently if it is in an excessively warm, salty, or dusty environment.

Overall: Perform a visual inspection checking for things such as discolored wires or terminals, evidence of arcing, loose mounting screws, physical damage to the enclosure, etc.

Power terminals: Inspect for loose connections and tighten to specifications in **Table 4**.

Fans and heatsinks: Excessive dust buildup on the heatsink and cooling fan impellers may lead to overheating. Lightly brush and vacuum clean. Contact Customer Service for assistance in replacing the cooling fan in the event it should fail. Use only fans approved by Phase Technologies. Unapproved fans may fail to cool the unit properly, risking component damage.

SOFTSTART

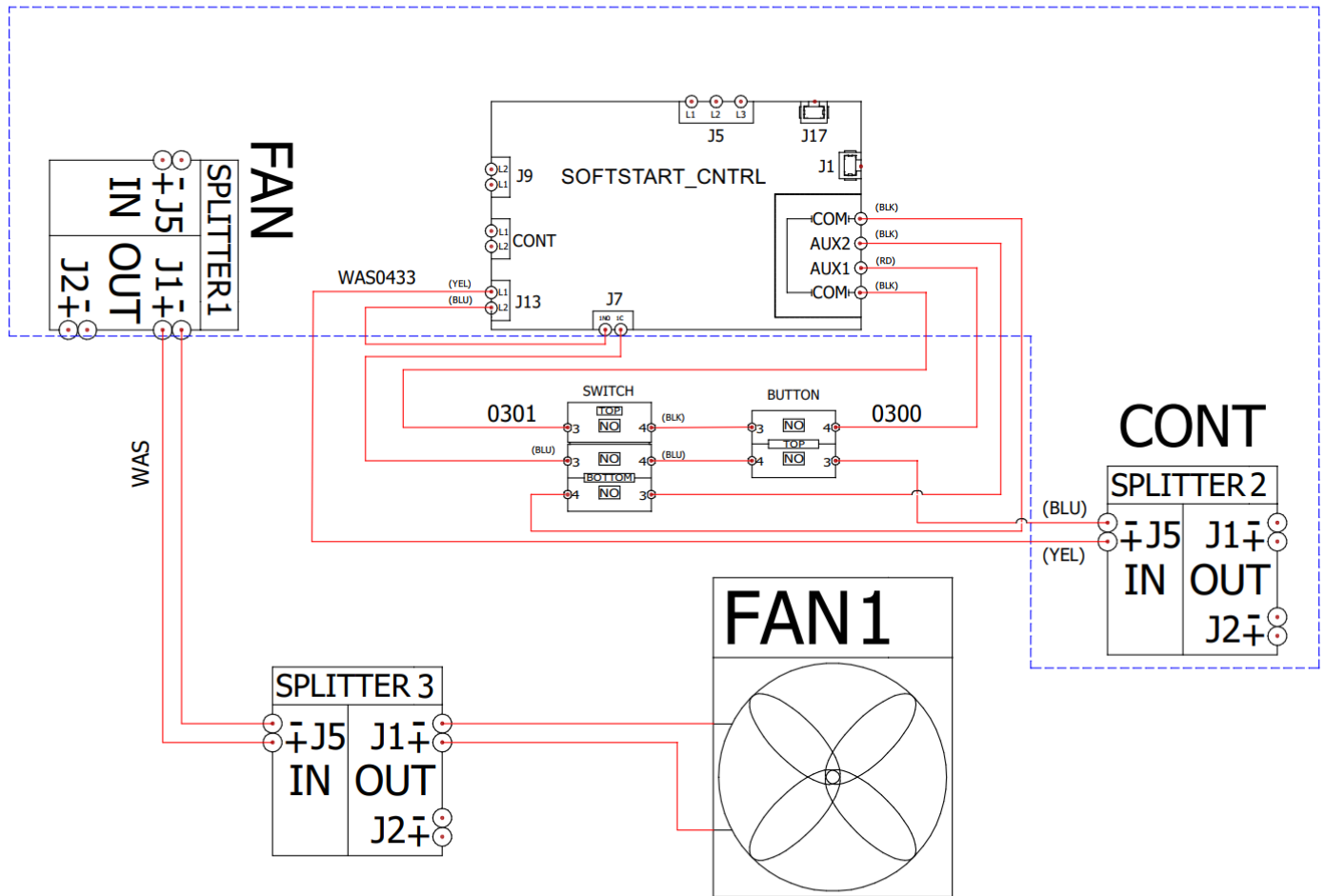

					REVISION	
					0	
	0	10/21/2025	darguelles			DOC0223
	REV.	DATE	NAME	SIGNOFF	CHANGES	
PANEL WIRING					OPTIONS BASIC	

Figure 12 – NEMA 3R Soft Start Panel Schematic

10 WARRANTY POLICY

LIMITED WARRANTY



Phase Technologies Soft Starters are warranted against defects in material and workmanship for a period of two years. This warranty covers both parts and labor (at Phase Technologies) for two years from the date of purchase by the original owner.

Phase Technologies will repair or replace (at our option), at no charge, any part(s) found to be faulty during the warranty period specified. The warranty repairs must be performed by/at a Phase Technologies Authorized Service Center or at Phase Technologies LLC, Rapid City, SD.

Obligations of the Original Owner

1. The original Bill of Sale must be presented to obtain "in-warranty" service.
2. Transportation to Phase Technologies or an Authorized Service Center is the responsibility of the original purchaser. Return transportation is provided by Phase Technologies.
3. Installations must comply with all national and local electrical codes.

Exclusions of the Warranty

This warranty does not cover any of the following: accident, misuse, fire, flood, and other acts of God, nor any contingencies beyond the control of Phase Technologies, LLC, including water damage, incorrect line voltage, improper installation, missing or altered serial numbers, and service performed by an unauthorized facility. Phase Technologies' liability for any damage caused in association with the use of Phase Technologies' equipment shall be limited to the repair or replacement only of Phase Technologies' equipment. No person, agent, distributor, dealer, or company is authorized to modify, alter, or change the design of this merchandise without express written approval of Phase Technologies, LLC.

Forum Selection

Any suit, claim, or cause of action arising from this document or any Phase Technologies product, will be governed by the laws of the State of South Dakota. It is agreed that jurisdiction and venue for all disputes will be the federal or state courts of South Dakota.

INSTALLATIONS MUST COMPLY WITH ALL NATIONAL AND LOCAL ELECTRICAL CODE REQUIREMENTS.